

KFB1053

Single handle pull-down kitchen faucet



Installation Manual

Installation / User Instructions / Warranty

Thank you for Choosing MAXTOR



MAXTOR mission is to provide "design & quality that you can count on" bathroom products. MAXTOR's advantages to you: first-class bathroom products, fashion & enduring design, sustainable production and excellent service. MAXTOR's team will stick to our original intention, do a good job in every product, and serve every one of our customers wholeheartedly.

Installation Considerations

- MAXTOR recommends the faucet be installed by a licensed, professional plumber.
- Make sure read over the instructions thoroughly before installation, and you have all tools and supplies needed to complete the installation.
- Be sure to thoroughly flush the supply pipes of dirt and debris.
- Turn off the water supply before commencing work at the stop valve.
- This is the single hole basin faucet, not include deck plate, the deck plate should be bought separately if install the faucet for three holes basin.
- Drain or a pull rod not be included also.
- The hot and cold supply hoses included with this faucet are for use with 3/8 stops. If your stops are a different size, purchase adapters at your local plumbing supply store or home center. Adapters are not available from MAXTOR.

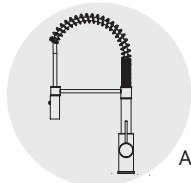

Care & Cleaning

A damp cloth and mild liquid dishwashing soap may be used, followed by rinsing with water and drying with a soft cloth. Most common household cleaners (including mild abrasives for Brushed Chrome and Platinum) can be used, when used in accordance with the manufacturers' instructions for use. However, all cleaners should be rinsed off thoroughly with water immediately after cleaning your faucet. Avoid using any harsh cleansers (e.g., steel wool or harsh chemicals) or pads/sponges that are unsafe for polished metallic surfaces. Most green, fibrous pads/sponges contain microscopic mineral particles that can scratch a faucet's finish. Cleaner manufacturers may change their formulations at any time; therefore, MAXTOR does not recommend any specific cleaner.

MAXTOR suggests the periodic application of a quality non-abrasive wax, such as car wax or furniture wax, especially for matte or textured finishes (e.g., Brushed gold, brushed Nickel Chrome or Chrome).

Removing Dried Water Spots:

A 50/50 blend of household vinegar and water can also be used for a limited amount of time, followed by rinsing with water and drying with a soft cloth.

Dimensions

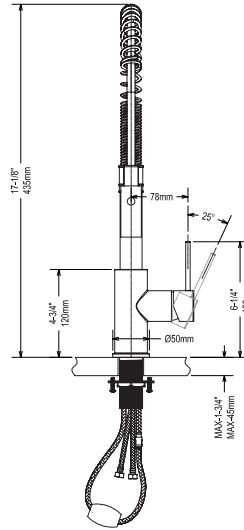
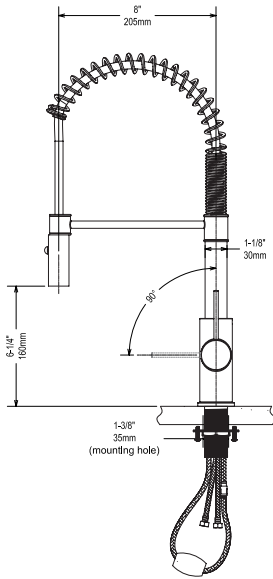

Tools Required



Philiper Screw driver



Adjustable Wrench



Teflon Tape

Installation Steps

1

Remark: First install, be sure to thoroughly flush the supply pipes of dirt and debris. Turn Off the angel valves after flush (Remove the old faucet), clean the mounting surface.

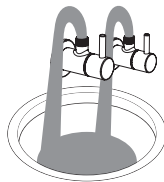

2

Remove mounting hardware.

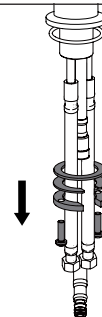

3

① For Single-Hole Sinks:

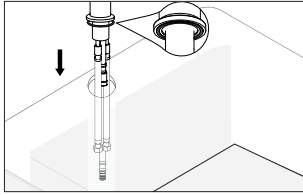

② For Three-Hole Sinks:

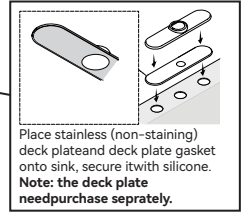
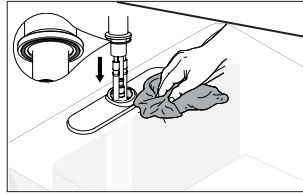

Put the rubber O-ring into the bottom gap of faucets then Insert faucet into faucet hole.

4

Install the rubber washer, metal washer and mounting nut. Tighten the mounting nut by hand.

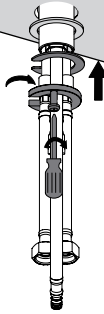

5

Connect the hoses to the stops. Use two wrenches, as shown in the diagram. Do not allow the hoses to twist.

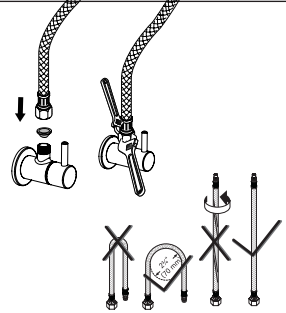

6

Turn on water suppliers. Place a bucket below outlet tube, slowly open and close the supply angle valves. This will prevent debris from being lodged in the hose and sprayer.

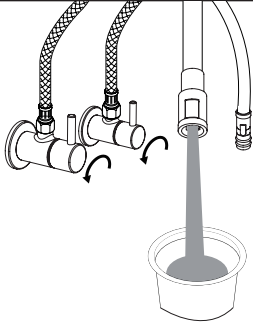

7

Shut off water suppliers. Push the handspray hose into the quick connector until you hear a click sound. Make sure it's secured.

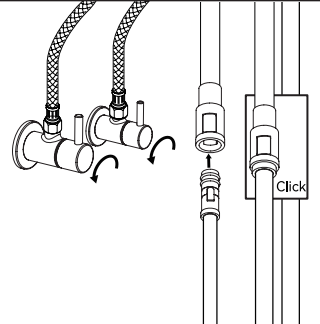

8

Install the gravity hammer. The gravity hammer is installed between 35-40 cm points from the threaded pipe for the optimal position.

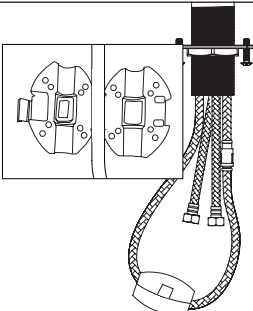

9

Turn on the water suppliers, Shut off the faucet and check for leaks.

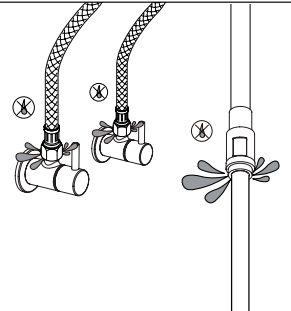

Troubleshooting

If you have followed the instructions carefully and your faucet still does not work properly, take the following coorrective steps:

PROBLEM	CAUSE	ACTION
Leakage under the handle	Bonnet nut has come loose	Remove the cover button.Loosen screw with hex wrench . Remove the handle. Unscrew cap (by hand only). Tighten bonnet nut with an adjustable wrench. Remove the cartridge. Check for cracks
Aerator drips or has inconsistent water flow pattern	Aerator is dirty or not seated properly	Unscrew aerator with a coin/ Housing/integrated thread and clean out debris
Water will not shut off completely	Cartridge may need tobe adjusted or replaced	Remove the cover button.Loosen screw with hex wrench. Remove the handle. Unscrew cap (by hand only). Tighten bonnet nut with an adjustable wrench. Remove the cartridge. Check for cracks
Lower flow	The filter washer in thehose connectors or Aerator is dirty	Turn off the water supply at water valve and unscrew the hose connectors from water supply lines. Clean the filter washer in the water lines with hot water, removing any debris or calcium build up.Take off the aerator and clean it with hot water.

Limited Lifetime Warranty

MAXTOR® provides our customers with an extensive warrant as a result of our excellent workmanship and high quality components used in our products.

Limited Lifetime Warranty: All parts of MAXTOR® faucet are warranted to the original consumer purchaser to be free from defects in material and workmanship for as long as the original consumer purchaser owns the home in which the faucet was first installed.

Surface finish warranty: A 5-years warranty is provided for all MAXTOR® faucet finishes to the original purchaser against manufacturing defects in workmanship.

Any labor charges incurred by the purchaser to repair, replace, install or remove this product are not covered by this warranty. MAXTOR Company shall not be liable for any damage to the faucet resulting from reasonable wear and tear, outdoor use, misuse (including use of the product for an unintended application), freezing water, abuse, neglect or improper or incorrectly performed installation, maintenance or repair, including failure to follow the applicable care and cleaning instructions. MAXTOR Company recommends using a professional plumber for all installation and repair.

What You Must Do To Obtain Warranty Service or Replacement Parts:

A warranty claim may be made and replacement parts may be obtained by contacting us by mail or online as follows (please include your model number and date of purchase):

Proof of purchase (original sales receipt) from the original purchaser must be made available to MAXTOR Company.

Or faucet with MAXTOR logo Pictures and "warranty card" picture(Each package with warranty card inside from MAXTOR company).

MAXTOR[®]

MAKE LIFE EASY



<https://aquasbath.com/>



admin@aquasbath.com



+86-757-85331862