

SPEC Sheet



Model: KFB1115

Two-Handles Single-Hole Kitchen Faucet

Available Colors/Finishes

Color tiles intended for reference only.

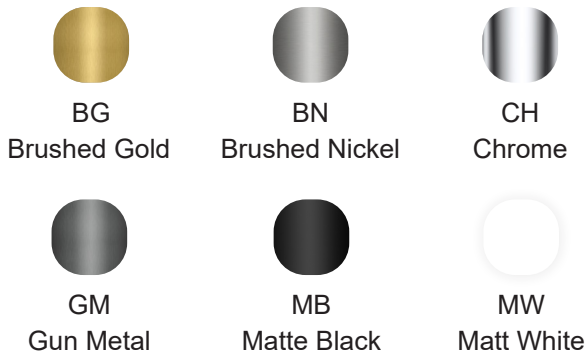

Lead-free



Water saving



Easy Control

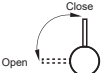

Easy Install



Rust Resistant



Specifications



Descriptions

- 3/8" speedway compression
- Ceramic cartridge
- Silent braided nylon hose



Certifications

- CSA B125.1
- NSF/ANSI standard 61 and 372
- ASME A112.18.1

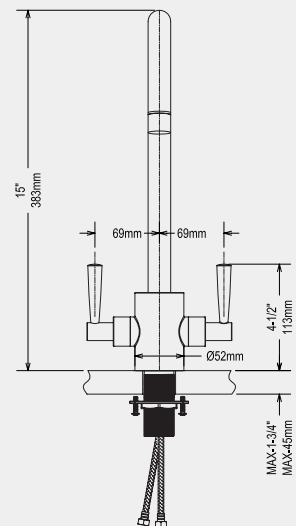
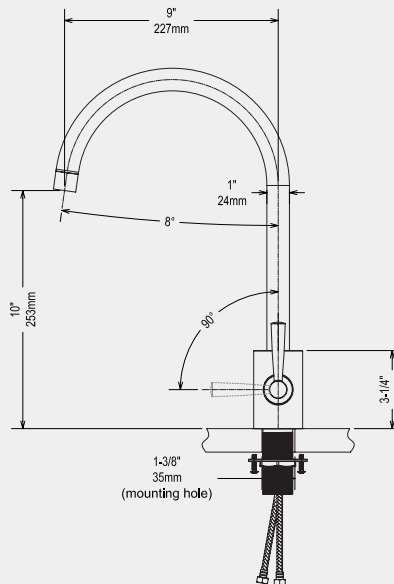

Material & Installation

- Premium solid lead-free brass construction for durability and reliability.
- MT surface finishes resist corrosion and tarnishing.
- Single-hole or three-hole installation (Deck plate needed to be buy separated).
- Preattached flexible supply lines simplify installation.

Water Conservation & Rebates

Model: KFB1115

Two-Handles Single-Hole Kitchen Faucet

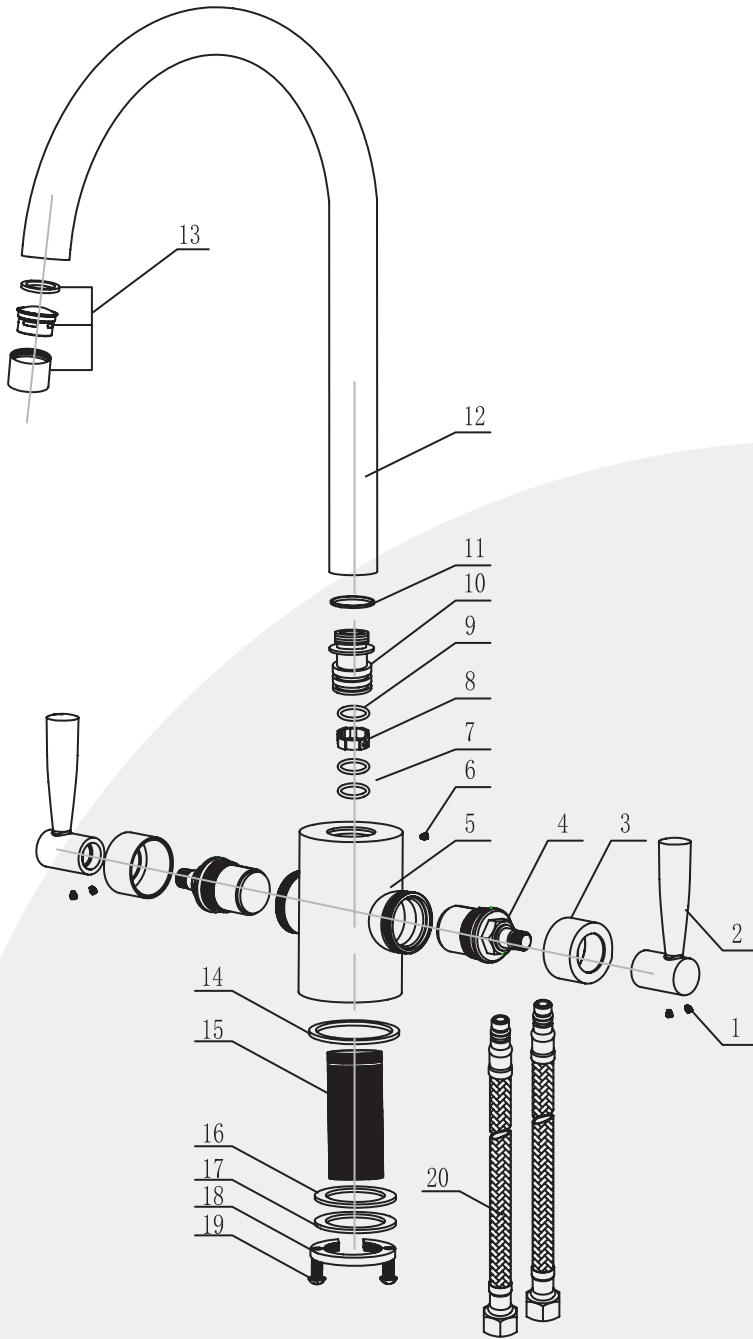

Lead-free



Water saving



Easy Control

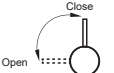

Easy Install



Rust Resistant



POS NO.	SPARE PART DESCRIPTION	Qty
1	Screw	4
2	Handle	2
3	Cartridge deco cover	2
4	Spain citec ceramic disc cartridge	2
5	Main body	1
6	Screw	1
7	O ring	2
8	Plastic buckle	1
9	O ring	1
10	Connector	1
11	O ring	1
12	Weighted ball	1
13	Nozzle assembly	1
14	O ring	1
15	Main screw tube	1
16	Rubber pad	1
17	Metal pad	1
18	Main body fixing nut	1
19	Screw	2
20	Hose 9/16-24UNEF-M8x4	1